

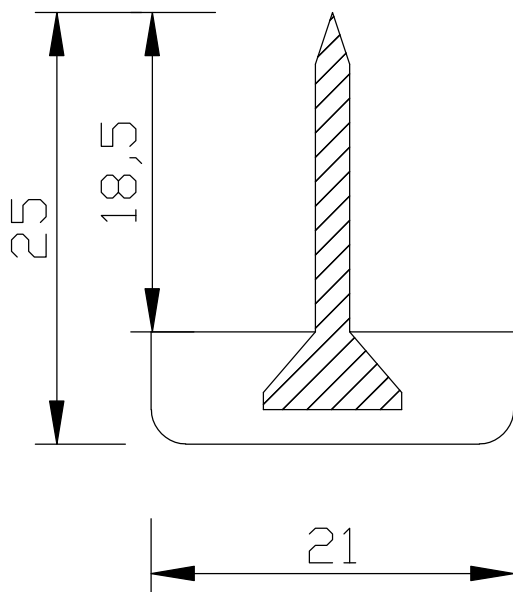

Sizes in millimeters  
Dimensions en millimètres



REFERENCE: F32028, F43883

